

TOSHIBA
Leading Innovation >>>

Transistor Inverter
TOSVERT VF-nC3



*Spice to
the Industry*



Transistor Inverter
TOSVERT™

VF-nC3

Transistor Inverter TOSVERT™ VF-nC3

Triple
Simple
Features

Operation

Set Up

Installation



Simple Set Up

Easy to set parameters

- Showing most frequently used parameters in easy mode.**
EASY key allows you switch between Easy mode and Standard mode.
Easy mode: Scrolls through a list of only seven parameters. You can optionally add up to 24 parameters to the list.
Standard mode: Rotates through all parameters.
- Guides you step by step through parameters you need to set up.**
Since the guidance feature shows one parameter at a time according to the selected function, you can interactively edit its value. Auto-guidance function is available with motor parameter setup, preset speed selection and analog signal control, etc.
- Searching for a history of changes in history function.**
History function makes change of parameter setting easily when some parameters are repeatedly set by the trial run and the adjustment, etc... History function automatically searches for 5 latest parameters that are set with different values from the standard default setting.
- Searching and resetting of changed parameters.**
User parameter group, *Uru*, automatically searches for only those parameters that are set with different values from the standard default setting and display them. This function makes the parameter setting check and resetting easily.

Built-in RS485 communication

Built-in RS485 communication enable to control the inverter and build network.

- Communication rate : 38.4 kbps max.
- Compatible with the Modbus RTU and Toshiba protocols.

You can connect a PC to manage parameters and monitor operating conditions.

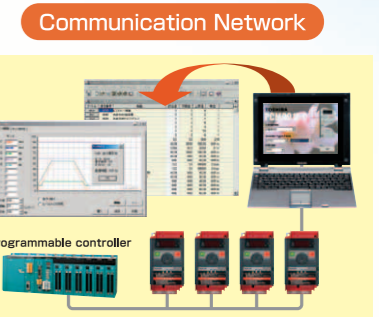

A RJ45 connector for RS485 communication is located on the bottom of the VF-nC3.

Simple Installation

The vertically oriented main circuit terminal block allows easy wiring.

Like power distribution devices, the main circuit terminal block of the VF-nC3 is vertically oriented to make wiring easy and minimize tangles of cable.

Side-by-side installation for space-saving

Generally, inverters must be placed in consideration of radiation of heat. The VF-nC3 can be placed side by side with no gap, saving inside of control panel space.*1

The covers for the main circuit terminal block ensure safety.

You can remove the covers for the main circuit terminal block with a screwdriver. Since the covers can be attached after the wiring of the main circuit terminal block, the VF-nC3 can be installed easily and safely.

*1: Necessary to reduce output current on some conditions.

Side-by-side installation



Main circuit terminal block cover



Simple Operation

The “turn-and-push” setting dial makes setup easily.

The large setting dial at the center of the front panel allows you to set the parameters easily. Just turn the setting dial until you get the right parameter and push the setting dial to select.

You can also use the setting dial to set the reference frequency.

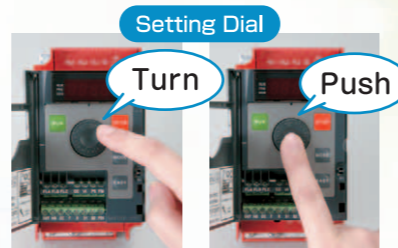

The RUN and STOP keys allow to operate easily.

You can operate the inverter with the **[RUN]** and **[STOP]** keys on the front panel. The front cover may be closed to conceal the other keys to avoid accidental key pressing.

RUN and STOP Keys



The Extension panel option allows to operate the VF-nC3 in front of the cabinet.

An extension panel option installed on the surface of the cabinet can operate the VF-nC3 in front of the cabinet.

It is possible to monitor the output frequency on the VF-nC3 and the output current on the extension panel option (RKP007Z). It is possible to use it as a digital meter.

*The extension panel option is connected to the inverter with the optional cable. In the extension panel option, there is no setting dial.

Extension panel option <RKP007Z>



● Models and Applicable Motors

Voltage (Input / Rated Output)	Applicable Motor Capacity (kW)						
	0.1	0.2	0.4	0.75	1.5	2.2	4.0
3ph-240V/3ph-240V	[Green bar]						
1ph-240V/3ph-240V	[Blue bar]						
1ph-120V/3ph-240V	[Purple bar]						

Index

Features	1
Application examples	4
Panel and operation procedure	5
Specification and dimensions	7
Connection diagram and terminal functions	9
List of parameters	11
Peripheral devices	13
For inverter users	16

Excellent Motor Control

The VF-nC3 brings out the best performance for kinds of different machine by various motor control modes suitable for its load characteristics.

If you just want to change the motor speed

First, select the default Constant V/f mode. If the default does not offer enough torque or you want to save more energy than the default provides, then you can select V/f Control mode to modify its parameters.

If you need higher torque for heavy-duty machines

Application examples: Conveyers; food mixers and slicers; exercise treadmills; car washing machines; applications for moving heavy or viscous materials; applications that require quick acceleration, etc.

The VF-nC3 supports sensorless vector control mode to generate stable, high-torque power from motor startup to a predefined, desired motor operating speed.

It is easy to set up motor parameters to achieve optimal vector control. You can do this simply by setting in the values on the name plate of a motor and selecting Auto-Tuning. The Auto-Guidance feature further simplifies setup by showing you necessary parameters once at a time interactively.

The factory defaults are set to values of the Toshiba standard motor (same capacity, 4-pole, 200 V, 60 Hz).

To save energy

Application examples: Fans; pumps; machines with small load variations that do not require high motor torque

The VF-nC3 offers Automatic Energy-Saving mode suitable for fans and pumps, which produces optimal current according to the load level.(You need to set up the motor parameters.)

Long Lifetime

Designed for 10 years of operation

The main-circuit capacitor, cooling fan and control board capacitors are designed for 10 years lifetime design.

(Conditions: Average annual ambient temperature = 40°C; output current = 80% of the rated current ;24 hours / 365 days. The designed lifetime is calculated value, not guaranteed one.)

The cooling fan is automatically turned on and off to further prolong the total lifetime.

Additionally, the VF-nC3 provides a capability to turn on and off cooling fans automatically in order to further prolong their lifetimes. This leads to energy-saving because cooling fans can be stopped while the VF-nC3 is idle.

Monitor informs when to replace major parts

The VF-nC3 tells you when to replace major parts and keeps track of the cumulative operation time. Since the VF-nC3 can generate warning, you can prevent a problem before it occurs.

Eco Design

Compliant with the European RoHS Directive

Built-in noise filters to suppress electromagnetic noise

The single-phase 240V model have built-in EMC noise filter comply with the European EMC Directive to reduce radio-frequency noise from the inverter.

This saves space and wiring, compared to using an external noise filter.

Single-phase 240V model: European EMC Directive
IEC/EN 61800-3 1st Environment, C1

Wide Variety of Applications

The VF-nC3 supports a wide range of machines, operating conditions and meets the needs of different geographical areas.

① Sink/source control logic

The VF-nC3 can be configured for both sink and source logic according to the target machine and the location where it is used.

② Power supplies: three-phase 240 V, single-phase 240 V and single-phase 120 V

The VF-nC3 can be used for a wide variety of applications from industrial machines to everyday equipment.

Note: For single-phase 240V and 120V inputs, the VF-nC3 provides a three-phase 240V output.

③ Maximum ambient temperature: 60°C

In many cases, the temperature in a cabinet gets higher than the ambient temperature. The VF-nC3 can be used at higher ambient temperatures*1.

④ Maximum altitude: 3000 meters

The VF-nC3 can be used at high altitudes*1.

⑤ Operating frequency range: 0.1 Hz to 400 Hz

The VF-nC3 supports a wide range of speed from low speed machines to high speed motors.

⑥ Programmable input and output terminals

The functions of the input and output terminals are programmable to meet the requirements for external circuitries and applications. Each terminal can be configured into a multi-functional terminal, and make it possible to simplify external circuitry.

Safety Features

Protects the setting parameters

The VF-nC3 provides protection for the setting parameters. For enhanced security, you can use a four-digit password. The VF-nC3 has a feature for saving and restoring a set of parameters.

The Monitor mode shows the load conditions.

① Monitoring the operating conditions

The front panel shows the operating conditions such as output current, rotational direction, input and output power, and so on. This feature is useful for checking the load conditions and adjusting parameters.

② Checking the trip status*2.

In the event of a protection trip, you can check the output current, input voltage and the like on a monitor to identify the cause of the problem and take countermeasures. The VF-nC3 remembers information about the last four trips even after you power it off.

Global Compliance

The VF-nC3 is compliant with major international standards.



EC directive (CE marking), UL, CSA

*1: The maximum output current may be limited or the label at the top of the unit need be removed, depending on the operating conditions.

*2 You can use the Monitor mode through RS485 communication.

Application Examples

Food Processing Machinery

Bakery equipment, confectionary equipment, tea-making machines, noodle-making machines, candy-wrapping machines, rice/barley milling machines, flour milling machines, food mixers, food slicers, fruit sorting machines, etc.

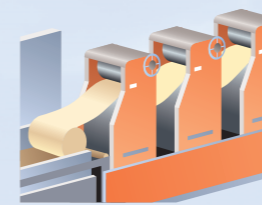

Food Processing Machine (Noodle-Making Machine)

- You can set the operating frequency according to the required work rate.
 1. You can fine-tune the operating frequency via an external contact inputs, depending on the conditions that workpiece materials and processes to be performed.
 2. The frequency is selectable in up to 15 steps through external contact inputs.
 3. The frequency is linearly adjustable via an analog input in the range 0 (4) to 20 mA, 0 to 10 V or 0 to 5 V.(an external potentiometer)
 4. The VF-nC3 can be programmed for smooth inching motion for final finishing work.

● RUN and STOP keys

The VF-nC3 can be programmed to generate one-shot pulses. Thus, operators can use a pedal switch to start and stop a machine.

● Ensures safety in the event of an instantaneous power failure.

Even when an instantaneous power failure occurs, the VF-nC3 can use regenerative energy from motor to bring the machine to a halt. The VF-nC3 ensures safety by preventing the machine to continue running by sheer inertia.

● Low noise

The VF-nC3 helps reduce acoustic noise from motors to the level that commercial power supply drive generates.

● Controls a machine with multiple inverters.

1. VF-nC3 can be controlled simultaneously through RS485 communication.
2. Each inverter can switch among multiple motors if their operations do not overlap in the course of a work process. The VF-nC3 can toggle between the basic settings for two motors.
3. VF-nC3 units can be installed side by side to save control panel space.

● Maximum ambient temperature: 60°C

The VF-nC3 can be used in high-temperature environments*.
* Depending on the operating conditions, the maximum output current may be limited or the label at the top of the unit may need to be removed.

● Protects the setting parameters.

The VF-nC3 provides password protection for parameters to prevent them from being altered inadvertently.

● High torque from startup to the rated speed

The VF-nC3 offers vector control and automatic torque boost control modes to achieve strong, stable torque from the start of a motor to the rated rotation speed. The VF-nC3 can control the motor to work persistently even when mixing viscous materials or cutting hard stuff.

- ... Frequency up/down input control
- ... Preset speed operation
- ... Jog run

- ... 3-wire control mode

- ... Deceleration stop in case of power failure

- ... PWM carrier frequency setting

- ... Switching to No.2 motor setting

- ... Password lock

Conveyance Machinery

Conveyors, automatic warehousing systems, etc.

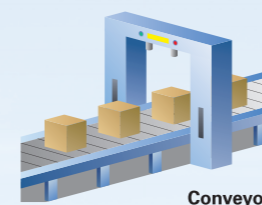

Conveyor

● Prevents the collapse of cargo on the conveyor.

The VF-nC3 allows you to mitigate the shocks caused in starting and stopping a conveyor and change the acceleration/deceleration rates according to the conveyor characteristics and its applications.

● Improves the braking performance.

The VF-nC3 can slow down a high-inertia machine in a short period of time without causing an overvoltage trip by increasing the energy consumed by the motor.

● Provides an operating status signal to the brake motor.

The VF-nC3 can turn on and off the braking circuitry in accordance with the inverter operating status.

● Shows the conveyor speed.

You can keep track of the operating status of a machine by displaying the conveyor speed on the inverter panel. If you use an optional remote panel, you can check the conveyor speed near the machine.

* The speed indication on the VF-nC3 is a value calculated from the operating frequency, may differ from the actual conveyor speed.

● The VF-nC3 provides smooth start up by high output torque.

The VF-nC3 offers vector control and automatic torque boost control modes to achieve strong, stable torque from the start of a motor to the rated speed. Additionally, the VF-nC3 responds quickly to abrupt load changes to keep a constant speed.

- ... S-curve acceleration/ deceleration, second acceleration/ deceleration times

- ... Quick deceleration control

- ... Low-speed detection output signal

- ... Free unit selection

Fans & Pumps

Built-in fans and pumps in industrial machines; water supply and sewage systems; driers, etc.

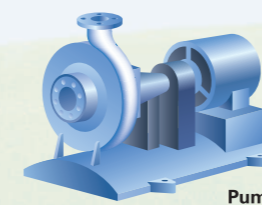

Pump

● Energy-saving mode

The Variable Torque and Automatic Energy-Saving modes help saving energy by passing optimal current in accordance with the load.

● Automatic process control

The VF-nC3 can be programmed to control temperatures, pressures and flow rates automatically. For temperature control, the PID control polarity is selectable via an input signal according to the selection of heating or cooling; this helps simplify system.

● Allows a motor to keep running and accelerate smoothly upon the recovery of power even in the event of an instantaneous power failure*.

Upon instantaneous power failure, the VF-nC3 utilizes regenerative energy from a motor to keep a machinerunning*. After power recovery, the VF-nC3 senses the motor's rotation speed and accelerates it smoothly to the programmed frequency.

* The running period varies with the mechanical characteristics and load conditions. The motor might free-run.

● Enables an uninterrupted operation without causing a trip

The VF-nC3 automatically lowers the operating frequency in the event of an overloaded condition. This prevents an overload trip for fans and pumps in which current decreases in proportion to the frequency. Also, if you decelerate a high-inertia apparatus like a fan at a quick rate, an overvoltage trip tends to occur due to regenerative energy. To avoid an overvoltage trip, the VF-nC3 allows you to adjust the braking period.

- ... PID control

- ... Regenerative power ride-through control
- ... Auto restart control

- ... Overload stall

- ... Overvoltage limit operation

Health, medical and nursing care equipment

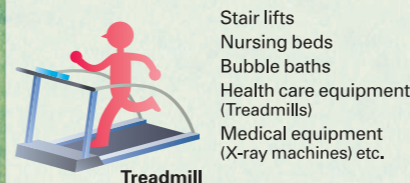

Treadmill

Stair lifts
Nursing beds
Bubble baths
Health care equipment (Treadmills)
Medical equipment (X-ray machines) etc.

Environment and daily-life-related machinery

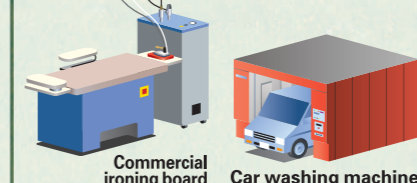

Commercial ironing board

Car washing machine

Commercial ironing boards
Car washing machines
Garbage disposers
Dust collectors
Driers etc.

Packing machinery

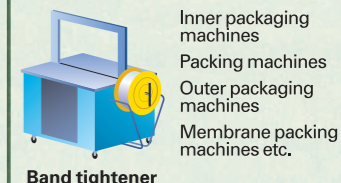

Band tightener

Inner packaging machines
Packing machines
Outer packaging machines
Membrane packing machines etc.

Panel and operation procedure



Note: The above photo only shows the front body of the VF-nC3, and its front cover is removed for an explanatory purpose. Be sure to put the VF-nC3 in use with its front cover.

TOSVERT™ VF-nC3

Power on (setup parameter)

① When power on the inverter for the first time, **SEt** is blinking.



② Select an area code by the setting dial.

JP | USA | AS1A | EU



③ Press the center of the setting dial to confirm your change. When **inIt** is displayed and then **0.0**, you finish setting the setup parameter.

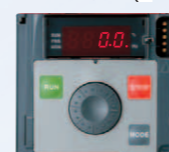

Monitor display

The LEDs on the operation panel display the following symbols indicate operations and parameters.

LED(number)

0	1	2	3	4	5	6	7	8	9	-
0	1	2	3	4	5	6	7	8	9	-

LED(alphabet)

Aa	Bb	C	c	Dd	Ee	Ff	Gg	H	h	I	i	Jj	Kk	Ll
R	b	l	c	d	E	F	G	H	h	i	l	u		L
Mm	Nn	O	o	Pp	Qq	Rr	Ss	Tt	Uu	Vv	Ww	Xx	Yy	Zz
n	n	0	a	p	q	r	s	t	u	v	w	x	y	z

Values set by each setup parameter

Title	Function	EU (Mainly in Europe)	USA (Mainly in North America)	AS1A (Mainly in Asia/Oceania)	JP (Mainly in Japan)
FH	Max.frequency	50.0(Hz)	60.0(Hz)	50.0(Hz)	80.0(Hz)
UL/L/F17	Frequency setting	50.0(Hz)	60.0(Hz)	50.0(Hz)	60.0(Hz)
F204	Frequency of V1 Input point2	50.0(Hz)	60.0(Hz)	50.0(Hz)	60.0(Hz)
UL/L/F171	Base frequency voltage 18.2	230(V)	230(V)	230(V)	200(V)
F127	Sink/source switching	100 [Source logic] (Positive common) (Common : P24) P24 F.R.S1.S2	0 [Sink logic] (Negative common) (Common : CC)		F.R.S1.S2 CC
F307	Power voltage compensation (Output voltage limit)	2	2	2	3
F417	Rated motor speed	1410(min ⁻¹)	1710(min ⁻¹)	1410(min ⁻¹)	1710(min ⁻¹)

Panel and operation procedure

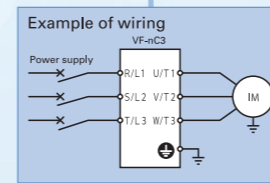

Operation

- Turn on the power. **0.0** is displayed.
- Operates VF-nC3 at the frequency set by the setting dial.
- Changes the output frequency.
- Decelerates and stops the motor.

Monitoring

- Displays operation frequency.
- Displays the motor rotating direction.
- Displays operation frequency command value.
- Displays output current (%/ampere)
- Displays operation frequency (returns to the beginning).

Setting

- Turn on the power. **0.0** is displayed.
- Displays "RUH".
- Displays "ACC".
- Displays the setting value.
- Displays "ACC", and the setting value alternately, and then the setting is completed.*

*If you press the center of the setting dial without changing the setting, the next parameter ("dEC") is displayed.

Item displayed	Panel operated	LED display	Description
Operation frequency *1		50.0	The operation frequency is displayed (Operation at 50Hz). (When standard monitor display selection F 7.10 is set at 0 (operation frequency))
Parameter setting mode	MODE	RUH	The first basic parameter "RUH" (history function) is displayed.
Direction of rotation	MODE	F _r -F	The direction of rotation is displayed. (F _r -F : forward run, F _r -r : reverse run)
Operation frequency command *1		F50.0	The operation frequency command value (Hz/free unit) is displayed. (In case of F 7.14=2)
Output current *1		C 80	The inverter output current (load current) (%/A) is displayed. (In case of F 7.12=1)
Input voltage *1		y100	The inverter input voltage (DC detection) (%/V) is displayed. (In case of F 7.13=3)
Output voltage *1		P100	The inverter output voltage (%/V) is displayed. (In case of F 7.14=4)
Inverter load factor *1		L 70	The inverter load factor (%) is displayed. (In case of F 7.15=2)
Operation frequency *1		o50.0	The operation frequency (Hz/free unit) is displayed. (In case of F 7.16=0)
Input terminal		R ...	The ON/OFF status of each of the control signal input terminals (F, R, S1, S2, V1) is displayed in bits. ON : OFF :
Output terminal		0 ..	The ON/OFF status of each of the control signal output terminals (OUT and FL) is displayed in bits. ON : OFF :

Item displayed	Panel operated	LED display	Description
Logic input terminals setting		L-50	Logic setting by F127 is displayed. L-50 : Source logic L-5 : Sink logic
CPU1 version		u101	The version of the CPU1 is displayed.
CPU2 version		uc01	The version of the CPU2 is displayed.
Past trip 1		0C3 ⇐1	Past trip 1 (displayed alternately) *2
Past trip 2		0H ⇐2	Past trip 2 (displayed alternately) *2
Past trip 3		0P3 ⇐3	Past trip 3 (displayed alternately) *2
Past trip 4		nErr ⇐4	Past trip 4 (displayed alternately) *2
Parts replacement alarm information		n ...	The ON/OFF status of the parts replacement alarm of the cooling fan, circuit board capacitor and main circuit capacitor, and cumulative operation time are displayed in bits. ON : OFF :
Cumulative operation time		t0.10	The cumulative operation time is displayed. (0.01=1 hour, 1.00=100 hours)
Default display mode	MODE	50.0	The operation frequency is displayed (Operation at 50Hz).

*1 These monitor items can be selected by setting parameters F701 to F716.(F720).
*2 Details on a past trip (of trips 1 to 4) can be displayed

Specifications and dimensions

Explanation of the name plate label

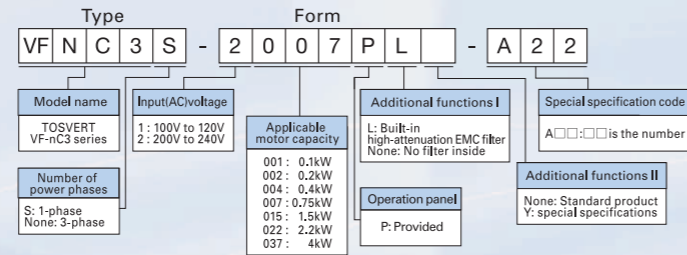

3-phase 240V class

Item	Specification							
Input voltage class	3-phase 240V class							
Applicable motor (kW)	0.1	0.2	0.4	0.75	1.5	2.2	4.0	
Rating	Type	VFNC3						
	Form	2001P	2002P	2004P	2007P	2015P	2022P	2037P
Power supply	Output Capacity (kVA) Note 1)	0.3	0.6	1.0	1.6	2.9	3.9	6.4
	Output current(A) Note 2)	0.7(0.7)	1.4(1.4)	2.4(2.4)	4.2(3.6)	7.5(7.5)	10.0(8.5)	16.7(14.0)
Power supply	Output voltage Note 3)	3-phase 200V to 240V						
	Overload current rating	150%-60 seconds, 200%-0.5 second						
	Voltage-frequency	3-phase 200V to 240V - 50/60Hz						
	Allowable fluctuation	Voltage 170 to 264V Note 4), frequency ±5%						
	Required Power supply capacity (kVA) Note 5)	0.5	0.8	1.4	2.5	4.3	5.7	9.2
Protective method (IEC60529)	IP20			IP20				
Cooling method	Self-cooling			Forced air-cooled				
Color	RAL 3002 / 7016							
Built-in filter	—							

1-phase 240V class / 1-phase 120V class

Item	Specification										
Input voltage class	1-phase 240V class					1-phase 120V class					
Applicable motor (kW)	0.1	0.2	0.4	0.75	1.5	2.2	0.1	0.2	0.4	0.75	
Rating	Type	VFNC3S									
	Form	2001PL	2002PL	2004PL	2007PL	2015PL	2022PL	1001P	1002P	1004P	1007P
Power supply	Output Capacity (kVA) Note 1)	0.3	0.6	1.0	1.6	2.9	3.9	0.3	0.6	1.0	1.6
	Output current(A) Note 2)	0.7(0.7)	1.4(1.4)	2.4(2.4)	4.2(3.2)	7.5(7.5)	10.0(9.1)	0.7(0.7)	1.4(1.4)	2.4(2.4)	4.2(4.0)
Power supply	Output voltage Note 3)	3-phase 200V to 240V					3-phase 200V to 240V				
	Overload current rating	150%-60 seconds, 200% -0.5 second					150%-60 seconds, 200% -0.5 second				
	Voltage-frequency	1-phase 200V to 240V - 50/60Hz					1-phase 100V to 120V - 50/60Hz				
	Allowable fluctuation	Voltage 170 to 264V Note 4), frequency ±5%					Voltage 85 to 132V Note 4), frequency ±5%				
	Required Power supply capacity (kVA) Note 5)	0.5	0.8	1.3	2.3	4.0	5.4	0.4	0.7	1.3	2.1
Protective method (IEC60529)	IP20					IP20					
Cooling method	Self-cooling					Self-cooling					
Color	RAL 3002 / 7016					RAL 3002 / 7016					
Built-in filter	EMC filter					—					

- Note 1.** Capacity is calculated at 220V for output voltage.
Note 2. Indicates rated output current setting when the PWM carrier frequency (parameter F302) is 4kHz or less. Between 5 kHz and 12 kHz, the rated output current is indicated in the (). Above 13 kHz, the output current must be reduced. The default setting of the PWM carrier frequency is 12kHz.
Note 3. Maximum output voltage is the same as the input voltage. In case of 1-phase 120V class, maximum output voltage is same as twice the input voltage. With regard to 120V models, the output voltage may decrease about 10 to 20 % if motor load is applied. When operating VF-nC3 in conjunction with general-purpose motor (200V), it is necessary to reduce the motor load.
Note 4. 180V-264V (240V class), 90V-132V (120V class) when the inverter is used continuously (load of 100%).
Note 5. Required power supply capacity varies with the value of the power supply side inverter impedance (including those of the input reactor and cables).

External dimensions

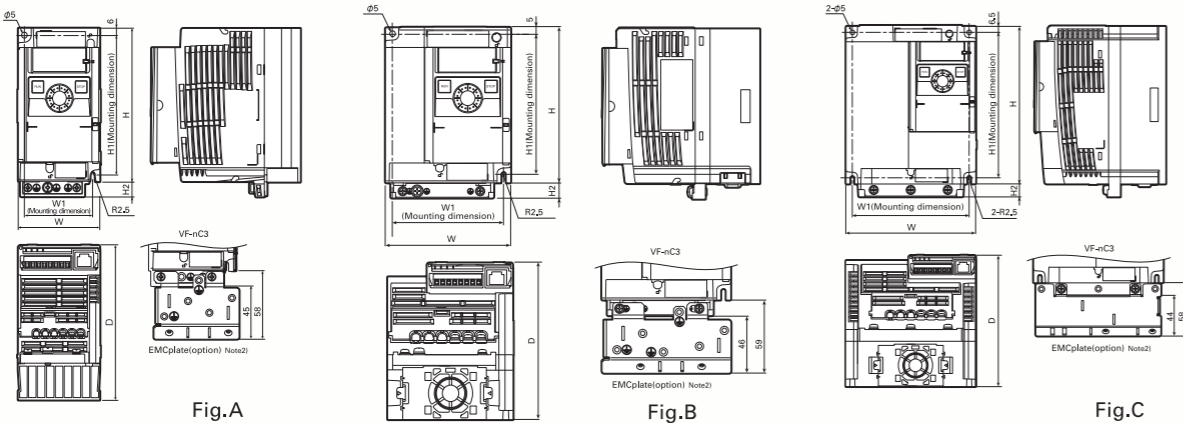

Voltage class	Applicable motor (kW)	Inverter type	Dimensions (mm)						Drawing	Approx. weight(kg)
			W	H	D	W1	H1	H2		
3-phase 240V	0.1	VFNC3-2001P	72	130	102	60	131	13	A	1.0
	0.2	VFNC3-2002P			121					
	0.4	VFNC3-2004P			131					
	0.75	VFNC3-2007P	105	130	131	93	118	12	B	
	1.5	VFNC3-2015P			156					
	2.2	VFNC3-2022P			156					
4.0	VFNC3-2037P	140	170	141	126	157	14	C	2.0	
1-phase 240V	0.1	VFNC3S-2001PL	72	130	102	60	131	13	A	1.0
	0.2	VFNC3S-2002PL			121					
	0.4	VFNC3S-2004PL			131					
	0.75	VFNC3S-2007PL	105	130	131	93	118	12	B	
	1.5	VFNC3S-2015PL			156					
	2.2	VFNC3S-2022PL			156					
1-phase 120V	0.1	VFNC3S-1001P	72	130	102	60	131	13	A	1.0
	0.2	VFNC3S-1002P			121					
	0.4	VFNC3S-1004P	105	130	121	93	118	12	B	
	0.75	VFNC3S-1007P			156					

- Note 1.** H2 : Height of EMC plate mounting area
Note 2. Here are the available EMC plate
 Fig.A : EMP007Z (Approx. weight : 0.3kg)
 Fig.B : EMP008Z (Approx. weight : 0.4kg)
 Fig.C : EMP009Z (Approx. weight : 0.5kg)
Note 3. The models shown in Fig. A to Fig. B are fixed at two points: in the upper left and lower right corners.
Note 4. The model shown in Fig. A is not equipped with a cooling fan. The models of 1-phase 240V and 1-phase 120V shown in Fig.B are equipped with a cooling fan on the top of the unit.
Note 5. Height measurements do not include the protrusions for installation.

Common specification

Item	Specification
Control system	Sinusoidal PWM control
Output voltage range	Adjustable within the range of 50 to 330V by correcting the supply voltage (However, cannot output voltage exceeding the input voltage.)
Output frequency range	0.1 to 400.0Hz, default setting: 0.5 to 80Hz, maximum frequency: 30 to 400Hz
Minimum setting steps of frequency	0.1Hz: analog input (when the max. frequency is 100Hz), 0.01Hz: Operation panel setting and communication setting.
Frequency accuracy	Digital setting: within ±0.1% of the max. frequency (-10 to +60°C) Analog setting: within ±1.0% of the max. frequency (25°C ±10°C)
Voltage/frequency characteristics	V/f constant, variable torque, automatic torque boost, vector control, automatic energy-saving, Auto-tuning, Base frequency (20 - 400Hz) adjusting to 1 & 2, torque boost (0 - 30%) adjusting to 1 & 2, adjusting frequency at start (0.1 - 10Hz)
Frequency setting signal	Setting dial on the front panel, external frequency potentiometer (connectable to a potentiometer with a rated impedance of 1k - 10kΩ), 0 - 10Vdc / 0 - 5Vdc (input impedance: VI=40kΩ, 4 - 20mAdc (input impedance: 250Ω), Note 1)
Terminal board base frequency	The characteristic can be set arbitrarily by two-point setting. Possible to set: analog input (VI).
Frequency jump	Setting of the jump frequency and the range.
Upper- and lower-limit frequencies	Upper-limit frequency: 0 to max. frequency, lower-limit frequency: 0 to upper-limit frequency
PWM carrier frequency	Adjustable within a range of 2k to 16kHz (default: 12kHz).
PID control	Setting of proportional gain, integral gain, differential gain and control waiting time.
Acceleration/deceleration time	Selectable from among acceleration/deceleration times 1 and 2 (0.0 to 3000 sec.), Automatic acceleration/deceleration function, S-pattern acceleration/deceleration 1 and 2. Control of forced rapid deceleration
DC braking	Braking start-up frequency: 0 to maximum frequency, braking rate: 0 to 100%, braking time: 0 to 25.5 seconds, emergency DC braking.
Dynamic Braking Drive Circuit	None (braking module is optional)
Input terminal function (programmable)	Possible to select from among about 60 functions, such as forward/reverse run signal input, jog run signal input, preset-speed signal input and reset signal input, to assign to 5 input terminals. Logic selectable between sink and source.
Output terminal functions (programmable)	Possible to select from among about 40 functions, such as upper/lower limit frequency signal output, low speed detection signal output, specified speed reach signal output and failure signal output, to assign to FL relay output, open collector output terminals.
Forward/reverse run	The RUN and STOP keys on the operation panel are used to start and stop operation, respectively. Forward/reverse run possible through communication and logic inputs from the terminal block.
Jog run	Jog mode, if selected, allows jog operation from the terminal board.
Preset speed operation	Frequency reference +15-speed operation possible by changing the combination of 4 contacts on the terminal board.
Retry operation	Capable of restarting automatically after a check of the main circuit elements in case the protective function is activated. 10 times (Max.) (selectable with a parameter)
Various prohibition settings / Password setting	Possible to write-protect parameters and to prohibit the change of panel frequency settings and the use of operation panel for operation, emergency stop or resetting. Possible to write-protect parameters by setting 4 digits password.
Regenerative power ride-through control	Possible to keep the motor running using its regenerative energy in case of a momentary power failure (default: OFF).
Auto-restart operation	In the event of a momentary power failure, the inverter reads the rotational speed of the coasting motor and outputs a frequency appropriate to the rotational speed in order to restart the motor smoothly. This function can also be used when switching to commercial power.
Failure detection signal	1c-contact output: (250 V ac - 2 A (cosφ=1): At resistive load, 30 V dc - 1 A, 250 V ac - 1 A (cosφ=0.4))
Protective function	Stall prevention, current limitation, over-current, output short circuit, over-voltage, over-voltage limitation, undervoltage, ground fault, detection, input phase failure, output phase failure, overload protection by electronic thermal function, armature over-current at start-up, load side over-current at start-up, over-torque, undercurrent, overheating, cumulative operation time, life alarm, emergency stop, various pre-alarms
Electronic thermal characteristic	Switching between standard motor and constant-torque VF motor, switching between motors 1 and 2, setting of overload trip time, adjustment of stall prevention levels 1 and 2, selection of overload stall
Reset function	Function of resetting by closing contact 1a or by turning off power or the operation panel. This function is also used to save and clear trip records.
Alarms	Stall prevention, overvoltage, overload, under-voltage, setting error, retry in process, upper/lower limits
Causes of failures	Over-current, overvoltage, overheat, output short-circuit, ground fault, inverter overload, over-current through arm at start-up, over-current through load at start-up, CPU fault, EEPROM fault, RAM fault, ROM fault, communication error. (Selectable: emergency stop, under-voltage, small current, over-torque, motor overload, input phase failure, output phase failure)
Monitoring function	Operation frequency, operation frequency command, forward/reverse run, output current, input voltage (DC detection), output voltage, torque, torque current, load factor of inverter, input power, output power, information on input terminals, information on output terminals, version of CPU1, version of CPU2, PID feedback value, frequency command (after compensation), logic input terminals setting, causes of past trips 1 to 4, parts replacement alarm, cumulative operation time
Past trip monitoring function	Stores data on the past four trips: number of trips that occurred in succession, operation frequency, direction of rotation, load current, input voltage (DC detection), output voltage, information on input terminals, information on output terminals, and cumulative operation time when each trip occurred.
Output for frequency meter	Analog output for meter: 1 mA dc full-scale dc ammeter 0 - 20 mA (4 to 20 mA) output: DC ammeter (allowable load resistance: Less than 750 Ω) 0 - 10 V output: DC voltmeter (allowable load resistance: Over 1kΩ)
4-digit 7-segments LED	Frequency: inverter output frequency. Alarm: stall alarm "C", overvoltage alarm "P", overload alarm "L", overheat alarm "H". Status: inverter status (frequency, cause of activation of protective function, input/output voltage, output current, etc.) and parameter settings. Free-unit display: arbitrary unit (e.g. rotating speed) corresponding to output frequency.
Indicator	Lamps indicating the inverter status by lighting, such as RUN lamp, MON lamp, PRG lamp, % lamp, Hz lamp. The charge lamp indicates that the main circuit capacitors are electrically charged.
Location of use	Indoors; not exposed to direct sunlight, corrosive gas, explosive gas, flammable gas, oil mist, or dust; and vibration of less than 5.9 m/s ² (10 to 55 Hz).
Elevation	3000 m or less (current reduction required over 1000 m) Note 2)
Ambient temperature	-10 to +60°C Note 3)
Storage temperature	-25 to +70°C
Relative humidity	5 to 95% (free from condensation and vapor).

- Note 1.** Be careful, if 4-20mA is selected, when the inverter's power is ON, the internal impedance is 250Ω, but when the power is OFF, the internal impedance increases very much to approximately 40kΩ.
Note 2. Current must be reduced by 1% for each 100 m over 1000 m. For example, 90% at 2000 m and 80% at 3000 m.
Note 3. Above 40°C : Remove the protective seal from the top of VF-nC3.
 Above 50°C : Remove the seal from the top of the inverter and use the inverter with the output current reduced. Side by side installation (with no space between inverters): Remove the seal from the top of each inverter. When installing the inverter where the ambient temperature will rise above 40°C, remove the seal from the top of the inverter and use the inverter with the output current reduced.

Connection diagram and terminal functions

Standard connection diagram

Standard connection diagram-(sink logic) (Negative)(common:CC)

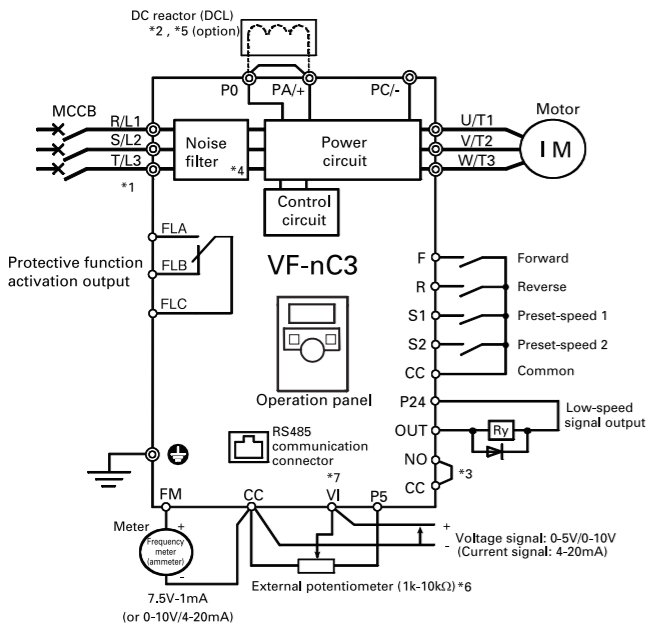

*1: Main circuit power supply
3ph-240V class: three-phase 200-240V-50/60Hz
1ph-240V class: single-phase 200-240V-50/60Hz
1ph-120V class: single-phase 100-120V-50/60Hz

The T/L3 terminal is not provided for single-phase models.
Use the R/L1 and S/L2/N terminals as input terminals.

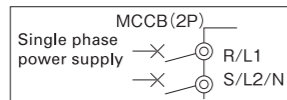

Standard connection diagram-(source logic) (Positive)(common:P24)

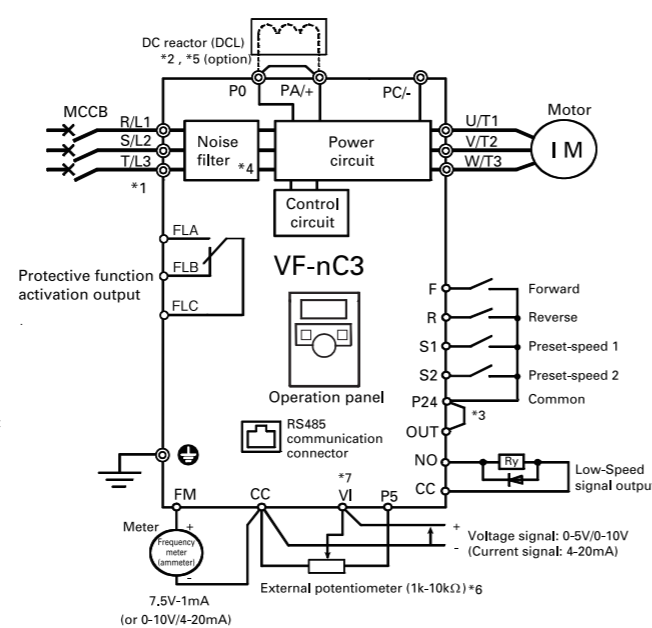

*2: The inverter is supplied with the PO and the PA+ terminals shorted by means of a shorting bar. Before installing the DC reactor (DCL), remove the bar.
*3: When using the OUT output terminal in sink logic mode, short the NO and CC terminals. When using the NO output terminal in source logic mode, short the P24 and OUT terminals.

*4: 1ph-240V models have noise filter inside.
*5: 1ph-120V models cannot be used with DC reactors.
*6: When external potentiometer is connected by using P5 terminal, set the parameter $F109=3$
*7: When using VI terminal as a logic input terminal, set the parameter $F109=2$ and connect as following schematics. Be sure to connect a resistor between P24 and VI terminals in case of sink logic, between VI and CC terminals in case of source logic. (Recommended resistance: 4.7kΩ-1/2W)

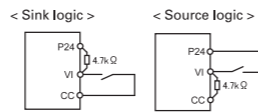

Main circuit terminal functions

Terminal symbol	Terminal function
	Grounding terminal for connecting inverter.
R/L1,S/L2,T/L3	1-phase 120V class: single-phase 100 to 120V-50/60Hz 1-phase 240V class: single-phase 200 to 240V-50/60Hz 3-phase 240V class: three-phase 200 to 240V-50/60Hz * Single-phase input: R/L1 and S/L2/N terminals
U/T1,V/T2,W/T3	Connect to a (three-phase induction) motor.
PC/-	This is a negative potential terminal in the internal DC main circuit. DC common power can be input across the PA terminals (positive potential). DC common power can not connect to 1-phase 120V models.
PO, PA/+	Terminals for connecting a DC reactor (DCL: optional external device). Shorted by a short bar when shipped from the factory. Before installing DCL, remove the short bar. 1-phase 120V models cannot be used with DC reactors.

Control circuit terminal functions

Terminal symbol	Terminal function	Electrical specifications
F	Shorting across F-CC causes forward rotation; open causes slowdown and stop. (When ST is always ON)3 different functions can be assigned.	No voltage logic input 24Vdc-5mA or less * Sink/Source selectable using parameter $F127$ (Explanation in case of sink logic)
R	Shorting across R-CC causes reverse rotation; open causes slowdown and stop. (When ST is always ON)3 different functions can be assigned.	
S1	Shorting across S1-CC causes preset speed operation. 2 different functions can be assigned.	
S2	Shorting across S2-CC causes preset speed operation. 2 different functions can be assigned.	
CC	Control circuit's equipotential terminal (2 terminals)	
P5	Analog power supply output	5Vdc (permissible load current: 10mA)
VI	Multifunction programmable analog input. Factory default setting: 0-10Vdc(10 bits resolution) and 0-60Hz (0-50Hz) frequency input. The function can be changed to 4-20mA current input by parameter $F109=1$ setting and 0-5Vdc (10 bits resolution) voltage input by parameter $F109=3$ setting. By changing parameter $F109=2$ setting, this terminal can also be used as a multifunction programmable logic input terminal. Be sure to insert a resistor between P24-VI (4.7 kΩ-1/2 W) in case of sink logic, between VI-CC in case of source logic.	5V/10Vdc (internal impedance: 40kΩ) 4-20mA (internal impedance: 250Ω) Note)
FM	Multifunction programmable analog output. Standard default setting: output frequency. The function can be changed to 0-10Vdc voltage or 0-20mA current output by parameter $F581$ setting.	1mA full-scale ammeter 0-20mA (4-20mA) DC ammeter Permissible load resistance: 750Ω or less 0-10V DC volt meter
P24	24Vdc power output	24Vdc-100mA
OUT NO	Multifunction programmable open collector output. Standard default setting : low speed signal. Multifunction output terminals to which two different functions can be assigned. The NO terminal is an isolectric output terminal. It is insulated from the CC terminal. By changing parameter settings,these terminals can also be used as multifunction programmable pulse train output terminals.	Open collector output 24Vdc-100mA To output pulse trains, a current of 10mA or more needs to be passed. Pulse frequency range: 38~1600pps
FLA FLB FLC	Multifunction programmable relay contact output. Detects the operation of the inverter's protection function. Contact across FLA-FLC is closed and FLB-FLC is opened during protection function operation.	250Vac-2A ($\cos\phi=1$): at resistance load 30Vdc-1A, 250Vac-1A, ($\cos\phi=0.4$)

Note) If 4-20mA is selected, when the inverter's power is ON, the internal impedance is 250Ω, but when the power is OFF, the internal impedance increases very much to approximately 40kΩ.

Wiring devices

Voltage class	Applicable motor (kW)	Inverter type	Input current (A)		Molded-case circuit breaker (MCCB) Earth leakage circuit breaker (ELCB) Note4)		Magnetic contactor (MC) Note1) 2) 3)		Wire size (mm ²) Note8)		
			No reactor	With DC reactor	Rated current (A)	Rated current (A)	No reactor	With DC reactor	Main circuit Note5)	DC reactor (optional)	Grounding cable Note7)
3-phase 240V	0.1	VFNC3-2001P	1.2	0.6	5	5	20	20	1.5(1.5)	1.5	2.5
	0.2	VFNC3-2002P	2.0	0.9	5	5	20	20	1.5(1.5)	1.5	2.5
	0.4	VFNC3-2004P	3.6	1.8	5	5	20	20	1.5(1.5)	1.5	2.5
	0.75	VFNC3-2007P	6.3	3.5	10	5	20	20	1.5(1.5)	1.5	2.5
	1.5	VFNC3-2015P	11.1	6.6	15	10	20	20	1.5(1.5)	1.5	2.5
	2.2	VFNC3-2022P	14.9	9.3	20	15	20	20	2.5(1.5)	1.5	2.5
1-phase 240V	0.1	VFNC3-2037P	23.8	16.1	30	30	32	20	4.0(2.5)	4.0	4.0
	0.1	VFNC3S-2001PL	2.0	1.2	5	5	20	20	1.5(1.5)	1.5	2.5
	0.2	VFNC3S-2002PL	3.4	2.1	5	5	20	20	1.5(1.5)	1.5	2.5
	0.4	VFNC3S-2004PL	5.9	4.1	10	5	20	20	1.5(1.5)	1.5	2.5
	0.75	VFNC3S-2007PL	10.2	7.7	15	10	20	20	1.5(1.5)	1.5	2.5
	1.5	VFNC3S-2015PL	17.8	14.8	30	20	20	20	2.5(2.5)	1.5	2.5
1-phase 120V	0.1	VFNC3S-2022PL	24	20.3	30	30	32	32	4.0(4.0)	1.5	4.0
	0.1	VFNC3S-1001P	3.5	-	5	-	20	-	1.5	-	2.5
	0.2	VFNC3S-1002P	6.0	-	10	-	20	-	1.5	-	2.5
	0.4	VFNC3S-1004P	11.4	-	15	-	20	-	2.5	-	2.5
	0.75	VFNC3S-1007P	18.9	-	30	-	20	-	4.0	-	4.0

- Note 1.** Be sure to attach a surge killer to the exciting coil of the relay and the magnetic contactor.
Note 2. When using the auxiliary contacts 2a of the magnetic contactor MC for the control circuit, connect the contacts 2a in parallel to increase reliability.
Note 3. When a motor is driven by commercial power supply using commercial power supply / inverter switching circuit, use a magnetic contactor appropriated AC-3 class the motor rated current.
Note 4. Select an MCCB with a rated interrupting current appropriate to the capacity of the power supply, because short-circuit currents vary greatly depending on the capacity of the power supply and the condition of the wiring system. The MCCB, MC and ELCB in this table were selected, on the assumption that a power supply with a normal capacity would be used.
Note 5. Sizes of the wires connected to the input terminals R/L1, S/L2 and T/L3 and the output terminals U/T1, V/T2 and W/T3 when the length of each wire does not exceed 30m. The numeric values in parentheses refer to the sizes of wires to be used when a DC reactor is connected.
Note 6. For the control circuit, use shielded wires 0.75 mm² or more in diameter.
Note 7. For grounding, use a cable with a size equal to or larger than the above.
Note 8. The wire sizes specified in the above table apply to HIV wires (copper wires shielded with an insulator with a maximum allowable temperature of 75°C) used at an ambient temperature of 50°C or less.

Multifunction programmable logic input/output

Logic input terminal

Terminal symbol	Parameter	Function	Action	Default setting
F	$F111$	Input terminal selection 1A	Set the function number to each parameters. Two or more functions can be set to one terminal. All functions operate by the signal input	2(Forward run)
	$F151$	Input terminal selection 1B		0(No function)
	$F155$	Input terminal selection 1C		0(No function)
R	$F112$	Input terminal selection 2A		4(Reverse run)
	$F152$	Input terminal selection 2B		0(No function)
	$F156$	Input terminal selection 2C		0(No function)
S1	$F113$	Input terminal selection 3A		10(Preset-speed command 1)
	$F153$	Input terminal selection 3B		0(No function)
S2	$F114$	Input terminal selection 4A		12(Preset-speed command 2)
	$F154$	Input terminal selection 4B		0(No function)
VI	$F109$	Analog/logic input selection (VI terminal)	Set $F109=2$ (Logic input) for logic input.	0(Voltage input signal 0 to 10V)
	$F115$	Input terminal selection 5	Set the function number.	14(Preset-speed command 3)

Note) When using the VI terminal as logic input terminal, be sure to connect a resistor between P24 and VI terminals in case of sink logic, between VI and CC terminals in case of source logic. (Recommended resistance: 4.7kΩ-1/2W)

Logic output terminal

Terminal symbol	Parameter	Function	Action	Default setting
OUT	$F130$	Output terminal selection 1A	Set the function number to each parameters. In case of using one function, please set $F130$.	4(Low speed detection)
	$F137$	Output terminal selection 1B		255(Always ON)
	$F139$	Output terminal logic selection	In case of set two functions, OUT outputs by 'AND'/'OR' logic.	0(AND)
	$F559$	Logic output/pulse train output selection	Select logic or pulse train output.	0(Logic)
FL(A, B, C)	$F132$	Output terminal selection 2	Set the function number.	10(Failure signal (trip output))

Note) All of logic output terminals are turned off about 0.5 to 1 second when power-on and fault reset. Please pay attention to use negative logic outputs.

List of parameters

Basic parameters

Operation frequency parameter

Title	Function	Adjustment range	Default setting
F C	Operation frequency of operation panel	LL-UL (Hz)	0.0

Other Basic parameters

Title	Function	Adjustment range	Default setting
RUH	History function	Displays parameters in groups of five in the reverse order to that in which their settings were changed. (Possible to edit)	-
RUF	Guidance function	0:1- 2: Preset speed guidance 3: Analog signal operation guidance 4: Motor 1&2 switching operation guidance 5: Motor constant setting guidance	0
RU1	Automatic acceleration/ deceleration	0: Disabled (manual setting) 1: Automatic 2: Automatic (only at acceleration)	0
RU2	Torque boost setting macro function	0: Disabled 1: Automatic torque boost + auto-tuning 2: Vector control + auto-tuning 3: Energy saving + auto-tuning	0
CND	Command mode selection	0: Terminal board 1: Panel keypad (including extension panel) 2: RS485 communication	1
FND	Frequency setting mode selection	0: Terminal board VI 1: Setting dial 1(Press the center to save) 2: Setting dial 2 (save even if power is off) 3: RS485 communication 4: - 5: UP/DOWN from external logic input	2
FNSL	Meter selection	0: Output frequency 1: Output current 2: Frequency reference 3: Input voltage (DC detection) 4: Output voltage (command value) 12: Frequency setting value (after compensation) 13: VI input value 15: Fixed output 1 (output current 100% equivalent) 16: Fixed output 2 (output current 50% equivalent) 17: Fixed output 3 (Other than the output current) 18: RS485 communication data 19: For adjustments (F Ω set value is displayed.) 5 to 11, 14, 20 to 22: -	0
FN	Meter adjustment gain	-	-
F r	Forward/reverse run selection (Panel keypad)	0: Forward run 1: Reverse run 2: Forward run (F/R switching on extension panel) 3: Reverse run (F/R switching on extension panel)	0

Title	Function	Adjustment range	Default setting
ACC	Acceleration time 1	0.0-3000(s)	10.0
DEC	Deceleration time 1	0.0-3000(s)	10.0
FH	Maximum frequency	30.0-400.0(Hz)	*1
UL	Upper limit frequency	0.5-FH(Hz)	*1
LL	Lower limit frequency	0.0-UL (Hz)	0.0
UL	Base frequency 1	20.0-400.0(Hz)	*1
ULV	Base frequency voltage 1	50-330(V)	*1
PE	V/F control mode selection	0: V/F constant 1: Variable torque 2: Automatic torque boost control 3: Vector control 4: Energy-saving	0
UB	Torque boost value 1	0.0-30.0(%)	*2
ETR	Motor electronic-thermal protection level 1	10-100(%)A	100
ELN	Electronic-thermal protection characteristic selection	Setting 0 1 2 3 4 5 6 7	0
SR1 ~ SR7	Preset-speed frequency 1 ~ 7	LL - UL (Hz)	0.0
ESP	Default setting	0: - 1: 50Hz default setting 2: 60Hz default setting 3: Default setting 1 (Initialization) 4: Trip record clear 5: Cumulative operation time clear 6: Initialization of type information 7: Save user setting parameters 8: Load user setting parameters 9: Cumulative fan operation time record clears 10 to 12: - 13: Default setting 2 (Complete initialization)	0
SEL	Checking the region setting	0: Start setup menu 1: Japan (read only) 2: North America (read only) 3: Asia (read only) 4: Europe (read only)	*1
PSEL	Registered parameter display selection	0: Standard setting mode at power on 1: Easy setting mode at power on 2: Easy setting mode only	0
F1-- ~ F8--	Extended parameter starting at 100 ~ 800	-	-
GRU	Automatic edit function	-	-

*1: Depends upon the setup parameter setting.
*2: Depends upon the capacity.

Extended parameters I

For details on extended parameters, please visit our website (<http://www.inverter.co.jp>).

Input terminal functions assignment

Title	Function	Adjustment range	Default setting
F108	Always active function selection 1	0-123	0
F109	Analog/logic input Selection (VI terminal)	0:0-10V 1:4-20mA 2:Logic input 3:0-5V	0
F110	Always active function selection 2	0-123	6
F111	Input terminal selection 1A (F)	0-201	2
F112	Input terminal selection 2A (R)	0-201	4
F113	Input terminal selection 3A (S1)	0-201	10
F114	Input terminal selection 4A (S2)	0-201	12
F115	Input terminal selection 5 (VI)	8-55	14
F151	Input terminal selection 1B (F)	0-201	0
F152	Input terminal selection 2B (R)	0-201	0
F153	Input terminal selection 3B (S1)	0-201	0
F154	Input terminal selection 4B (S2)	0-201	0
F155	Input terminal selection 1C (F)	0-201	0
F156	Input terminal selection 2C (R)	0-201	0

Output terminal functions assignment

Title	Function	Adjustment range	Default setting
F130	Output terminal selection 1A (OUT)	0-255	4
F132	Output terminal selection 2 (FL)	0-255	10
F137	Output terminal selection 1B (OUT)	0-255	255
F139	Output terminal logic selection (OUT)	0:F130 and F137 0:F130 or F137	0
F100	Low-speed signal output frequency	0.0-FH(Hz)	0.0
F101	Speed reach setting frequency	0.0-FH(Hz)	0.0
F102	Speed reach detection band	0.0-FH(Hz)	2.5

Input terminal function

Function No.	Positive logic	Negative logic	Function
0,1			No function assigned
2	3		Forward run command
4	5		Reverse run command
6	7		Stand by
8	9		Reset command
10	11		Preset-speed command 1
12	13		Preset-speed command 2
14	15		Preset-speed command 3
16	17		Preset-speed command 4
18	19		Jog run mode
20	21		Emergency stop by external signal
22	23		DC braking command
24	25		2nd Acceleration/Deceleration
28	29		2nd V/F setting switching
32	33		2nd stall prevention level
36	37		PID control prohibition
48	49		Switching from communications to local
50	51		Operation hold (hold of 3-wire operation)
52	53		PID integral/derivative clear
54	55		PID characteristics switching
88	89		Frequency UP signal input from external contacts
90	91		Frequency DOWN signal input from external contacts
92	93		Clear frequency UP/DOWN signal input from external contacts
96	97		Coast stop command
106	107		Switch to frequency command terminal board
108	109		Command mode terminal board
110	111		Parameter editing permitted
122	123		Forced deceleration command
200	201		Parameter editing prohibit

Output terminal function

Function No.	Positive logic	Negative logic	Function
0	1		Frequency lower limit
2	3		Frequency upper limit
4	5		Low-speed detection signal
6	7		Output frequency arrival signal (acceleration/deceleration completed)
8	9		Designated frequency arrival signal
10	11		Fault signal trip output
14	15		Overcurrent detection pre-alarm
16	17		Overload detection pre-alarm
20	21		Overheat detection pre-alarm
22	23		Overvoltage detection pre-alarm
24	25		Main circuit undervoltage detection
26	27		Small current detection
28	29		Over-torque detection
40	41		Run/stop
56	57		Cumulative operation time alarm
60	61		Forward/reverse run
78	79		RS485 communications error
92	93		Designated data output
128	129		Parts replacement alarm
146	147		Fault signal (output also at a retry)
254/255			Always OFF / ON

PWM carrier frequency

Set parameters to suppress the acoustic noise of motor or electro-magnetic noise.

Title	Function	Adjustment range	Default setting
F300	PWM carrier frequency	2-16(KHz)	12
F312	Random mode	0: Disabled, 1: Automatic setting	0
F316	Carrier frequency control mode selection	0: Carrier frequency without reduction 1: Carrier frequency with automatic reduction	1

Panel display

Set parameters to change the monitoring content and unit displayed on the panel.

Title	Function	Adjustment range	Default setting
F701	Current/voltage unit selection	0%: 1A/V	0
F702	Free unit display scale	0.00: Disabled (display of frequency) 0.01-200.0	0.00
F707	Free step (1-step rotation of setting dial)	0.00: Disabled 0.01-FH	0.00
F710	Initial panel display selection	0, 1, 2, 18, 52	0
F720	Initial remote keypad display selection	0, 1, 2, 18, 52	0

Sink/source switching

Set parameter to select the logic of control circuit.

Title	Function	Adjustment range	Default setting
F127	Sink/source switching	0: Sink, 100: Source, 1-99, 101-255: invalid	*1

Frequency command (terminal board)

Set parameters to set the characteristic of frequency reference from input terminals.

Title	Function	Adjustment range	Default setting
F201	VI Input point 1 setting	0-100(%)	0
F202	VI Input point 1 frequency	0.0-400.0(Hz)	0.0
F203	VI Input point 2 setting	0-100(%)	100
F204	VI Input point 2 frequency	0.0-400.0(Hz)	*1
F209	Analog input filter	4-1000(ms)	64
F470	VI input bias	0-255	128
F471	VI input gain	0-255	128

Protection 1

Set parameters to set some protective functions.

Title	Function	Adjustment range	Default setting
F301	Auto-restart control selection	0, 1, 2, 3, 4	0
F302	Regenerative power ride-through control (Deceleration stop)	0, 1, 2	0
F303	Retry selection (number of times)	0: Disabled, 1-10 (Times)	0
F305	Overvoltage limit operation (Slowdown stop mode selection)	0, 1, 2, 3	2
F307	Supply voltage corrensation (output voltage limit)	0, 1, 2, 3	*1
F601	Stall prevention level 1	10-199 (%/A), 200 (disabled)	150
F602	Inverter trip retention selection	0: Cleared with power off 1: Retained with power off	0
F603	Emergency stop selection	0, 1, 2	0
F605	Output phase failure detection selection	0, 1, 2	0
F607	Motor 150%-overload detection time	10-2400(s)	300
F608	Input phase failure detection selection	0: Disabled, 1: Enabled	1

Torque up (motor setting)

Set parameters for vector control and automatic torque boost control.

Title	Function	Adjustment range	Default setting
F400	Auto-tuning	0, 1, 2	0
F401	Slip frequency gain	0-150(%)	50
F402	Automatic torque boost value	0.0-30.0(%)	*2
F405	Motor rated capacity	0.01-5.50(kW)	*2
F415	Motor rated current	0.1-30.0(A)	*2
F416	Motor no-load current	10-90(%)	*2
F417	Motor rated speed	100-32000(min-1)	*1
F459	Load inertia moment ratio	0.1-100.0(Times)	1.0

Extended parameters II

For details on extended parameters, please visit our website (<http://www.inverter.co.jp>).

PID control

Title	Function	Adjustment range	Default setting
F359	PID control waiting time	0-2400(s)	0
F360	PID control	0: Disabled, 1: Enabled	0
F362	Proportional gain	0.01-100.0	0.30
F363	Integral gain	0.01-100.0	0.20
F366	Differential gain	0.00-2.55	0.00
F380	PID forward/reverse characteristics selection	0: Forward, 1: Reverse	0

Preset-speed operation

Title	Function	Adjustment range	Default setting
F287 ~ F294	Preset-speed frequency 8-15	LL - UL (Hz)	0.0

No.2 Acceleration/deceleration time

Title	Function	Adjustment range	Default setting
F500	Acceleration time 2	0.0-3000(s)	10.0
F501	Deceleration time 2	0.0-3000(s)	10.0
F502	Acceleration/deceleration 1 pattern	0: Linear	0
F503	Acceleration/deceleration 2 pattern	1: S-pattern 1, 2: S-pattern 2	0
F505	Acceleration/deceleration 1 and 2 switching frequency	0.0 (disabled) 0.1-UL (Hz)	0.0

No.2 motor

Title	Function	Adjustment range	Default setting
F170	Base frequency 2	20.0-400.0(Hz)	*1
F171	Base frequency voltage 2	50-330(V)	*1
F172	Torque boost value 2	0.0-30.0(%)	*2
F173	Motor electronic-thermal protection level 2	10-100(%) A	100
F185	Stall prevention level 2	10-199(%) A, 200 (disabled)	150

Jump frequency

Title	Function	Adjustment range	Default setting
F270	Jump frequency	0.0-FH(Hz)	0.0
F271	Jumping width	0.0-30.0(Hz)	0.0

DC braking

Title	Function	Adjustment range	Default setting
F250	DC braking starting frequency	0.0-FH(Hz)	0.0
F251	DC braking current	0-100(%) / A	50
F252	DC braking time	0.0-25.5(S)	1.0

Forward/reverse

Title	Function	Adjustment range	Default setting
F105	Priority selection (Both F and R are ON)	0: Reverse, 1: Slowdown Stop	1
F311	Reverse-run prohibition	0, 1, 2	0

Starting frequency

Title	Function	Adjustment range	Default setting
F240	Starting frequency setting	0.1-10.0(Hz)	0.5
F241	Operation starting frequency	0.0-FH(Hz)	0.0
F242	Operation starting frequency hysteresis	0.0-FH(Hz)	0.0

Frequency up/down feature

Title	Function	Adjustment range	Default setting
F264	External logic input - UP response time	0.0-10.0(s)	0.1
F265	External logic input - UP frequency steps	0.0-FH(Hz)	0.1
F266	External logic input - DOWN response time	0.0-10.0(s)	0.1
F267	External logic input - DOWN frequency steps	0.0-FH(Hz)	0.1
F268	Initial value of UP/DOWN frequency	LL - UL (Hz)	0.0
F269	Change of the initial value of UP/DOWN frequency	0, 1	1

Analog/pulse train output

Title	Function	Adjustment range	Default setting
F669	Logic output/pulse train output selection (OUT)	0: Logic output, 1: Pulse train output	0
F676	Pulse train output function selection (OUT)	0-18: same as F75L, 19-22: -	0
F677	Maximum numbers of pulse train	0.50-1.60(kpps)	0.80
F681	Analog output signal selection	0: Meter, 1: Current (0 to 20 mA) output, 2: Voltage (0 to 10 V) output	0
F691	Inclination characteristic of analog output	0: Negative (downward slope) 1: Positive (upward slope)	1
F692	Analog output bias	-1.0-+100.0(%)	0

Communication

Title

Peripheral devices

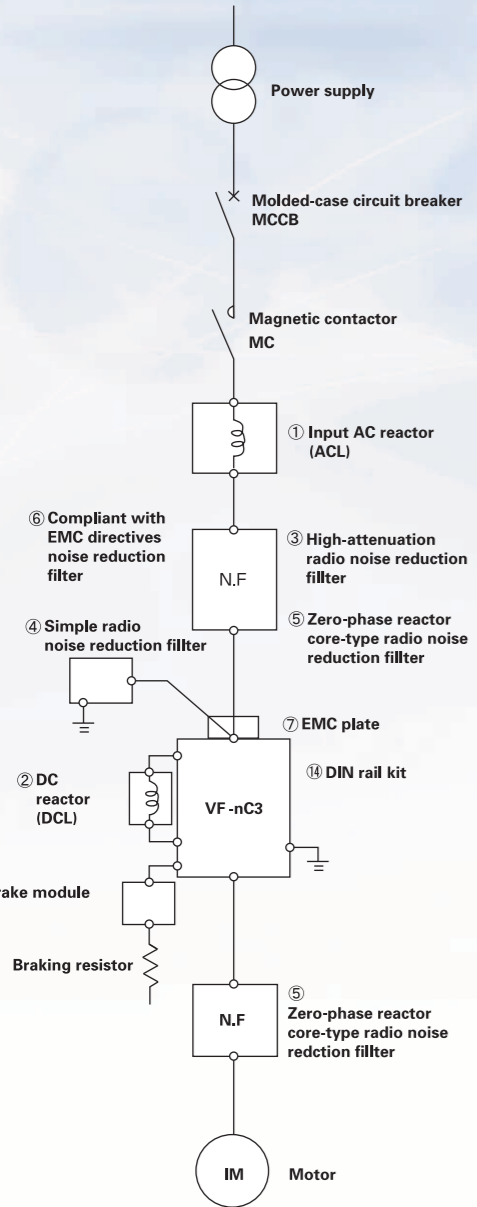

No.	Device	Function, Purpose, etc.	Refer to
①	Input AC reactor	Used to improve the input power factor, reduce the harmonics, and suppress external surge on the inverter power source side. Install when the power capacity is 200kVA or more and 10 times or more than the inverter capacity or when a distorted wave generation source such as a thyristor unit or a large-capacity inverter is connected in the same distribution system.	P.14
②	DC reactor	Improves the power factor more than the input reactor. When the facility applying the inverter requires high reliability, it is recommended to use the DC reactor with an input reactor effective for external surge suppression.	
③	High-attenuation filter (LC filter) NF type	These type of filters are not necessary for single-phase 240V (built-in EMC noise filter) model. The built-in filter meets IEC61800-3. ● Effective to prevent interference with audio equipment used near the inverter. ● Install on the input side of the inverter. ● Provided with wide-range attenuation characteristics from AM radio bands to near 10MHz. ● Use when equipment readily affected by noise is installed in the peripheral area.	P.14
④	Simple filter (capacitive filter) Capacitor type	● Effective to prevent interference with audio equipment used near the inverter. ● Install on the input side of the inverter. ● Attenuation characteristic is available only in a specific frequency and, effective in suppressing noise in a specific AM radio station (e.g., weak radio waves in mountainous regions). ● Increases leakage current because this is a capacitor-based filter. When the power supply is equipped with an ELCB, avoid using too many filters of this type.	
⑤	Radio noise reduction filter	Zero-phase reactor (inductive filter) core type ● Effective to prevent interference with audio equipment used near the inverter. ● Effective in noise reduction on both input and output sides of the inverter. ● Provided with attenuation characteristics of several dB in frequencies from AM radio bands to 10MHz. ● For noise countermeasures, insert on the secondary side of the inverter.	P.15
⑥	Compliant with EMC directives noise reduction filter	This noise filter complies with European EMC Directive. *These type of filters are not necessary for single-phase 240V (built-in EMC noise filter) model. The built-in filter meets IEC61800-3 C1.	
⑦	EMC plate	A steel plate used to connect shielded grounding cables from inverter's power cables or to connect grounding cables from external devices.	P.7
⑧	Brake module	Use when rapid deceleration or stop is frequently required or when it is desired to reduce the deceleration time with large load. This module and resistor consumes regenerative energy during power generation braking. For 0.1 to 2.2kW models. <Type: BRMD0015Z>	—
⑨	Extension panel (parameter writer)	LED remote keypad is for extension. It is provided with an LED display, some operational keys. The panel with parameter writer function can setup and read the parameters for inverter.	P.15
⑩	USB communication unit	This unit is connected to a PLC or a computer to enable data communications. By connecting the connector cable, parameters can be easily adjusted, and data easily saved and written.	P.15
⑪	Remote panel	Has a built-in frequency meter, frequency setter and RUN-STOP (forward run, reverse run) switch.	P.15
⑫	Frequency meter	Use to mount the meter on an external operation unit.	P.15
⑬	FRH kit	FRH-kit includes frequency setting resistor, panel and knob for an external operation unit.	P.15
⑭	DIN rail kit	Use to mount the inverter on DIN rails. For 0.1 to 2.2kW models. <Type: DIN003Z, DIN005Z>	—

Peripheral devices

Voltage class	Inverter model	Applicable motor (kW)	Input AC reactor (ACL)	DC reactor (DCL)	Radio noise reduction filter		
					High-attenuation filter	Simple filter	Zero-phase reactor
3-phase 240V	VFNC3-2001P	0.1	PFL2001S	DCL2-2002	NF3005A-MJ	RCL-M2	RC5078
	VFNC3-2002P	0.2	PFL2001S	DCL2-2002			
	VFNC3-2004P	0.4	PFL2005S	DCL2-2004			
	VFNC3-2007P	0.75	PFL2005S	DCL2-2007			
	VFNC3-2015P	1.5	PFL2011S	DCL2-2015			
	VFNC3-2022P	2.2	PFL2011S	DCL2-2022			
	VFNC3-2037P	4.0	PFL2018S	DCL2-2037			
1-phase 240V	VFNC3S-2001PL	0.1	PFLS2002S	DCL2-2002	The EMC noise filter is built into the 1ph-240V models by the standard.	RC5078	
	VFNC3S-2002PL	0.2	PFLS2002S	DCL2-2004			
	VFNC3S-2004PL	0.4	PFL2005S	DCL2-2007			
	VFNC3S-2007PL	0.75	PFL2011S	DCL2-2015			
	VFNC3S-2015PL	1.5	PFL2018S	DCL2-2037			
VFNC3S-2022PL	2.2	PFL2018S	DCL2-2037				
1-phase 120V	VFNC3S-1001P	0.1	PFL2005S	1ph-120V models cannot be used with DC reactors.	NF3005A-MJ	RCL-M2	RC5078
	VFNC3S-1002P	0.2	PFL2005S				
	VFNC3S-1004P	0.4	PFL2018S				
	VFNC3S-1007P	0.75	PFL2018S				

External dimensions and connections

Input AC reactor (ACL)

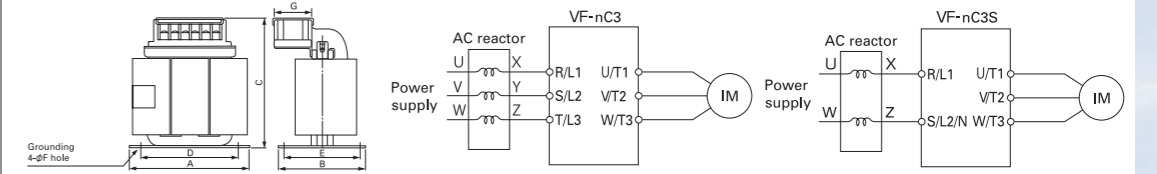

Model	Rating	Inverter type		Dimensions(mm)							Terminal (Terminal block)	Approx. weight (kg)
		VFNC3-	VFNC3S-	A	B	C	D	E	F	G		
PFLS2002S	1-phase 200V class -2.0A-50/60Hz	—	2001PL,2002PL	80	55	115	65	45	5	45	M 3.5	0.85
PFL2001S	3-phase 200V class -1.7A-50/60Hz	2001P,2002P	—	105	65	115	90	55	5	40	M 3.5	1.0
PFL2005S	3-phase 200V class -5.5A-50/60Hz	2004P,2007P	2004PL,1001P,1002P	105	65	115	90	55	5	40	M 3.5	1.2
PFL2011S	3-phase 200V class -11A-50/60Hz	2015P,2022P	2007PL	130	70	140	115	60	5	50	M4	2.3
PFL2018S	3-phase 200V class -18A-50/60Hz	2037P	2015PL,2022PL 1004P,1007P	130	70	140	115	60	5	50	M4	2.5

*PFLS2002 has 4 terminals.

DC reactor (DCL)

1ph-120V models cannot be used with DC reactors. Please select input AC reactors.

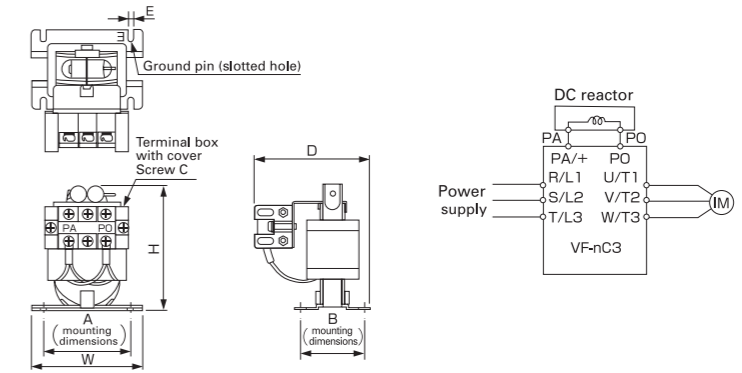

Model	Rated current (A)	Inverter type		Dimensions(mm)							Approx. weight (kg)
		VFNC3-	VFNC3S-	W	H	D	A	B	C	E	
DCL2-2002	1.8	2001P,2002P	2001PL	63	79	72	48	32	M3.5	4.5	0.4
DCL2-2004	4	2004P	2002PL	72	92	75	57	42	M3.5	4.5	0.6
DCL2-2007	6	2007P	2004PL	72	94	80	57	42	M3.5	4.5	0.7
DCL2-2015	9.5	2015P	2007PL	75	99	79	60	42	M3.5	4.5	0.9
DCL2-2022	13	2022P	—	74	101	81	59	47	M3.5	4.5	1.0
DCL2-2037	21	2037P	2015PL,2022PL	81	115	99	65	56	M4	5.0	1.6

High-attenuation radio noise reduction filter (NF type)

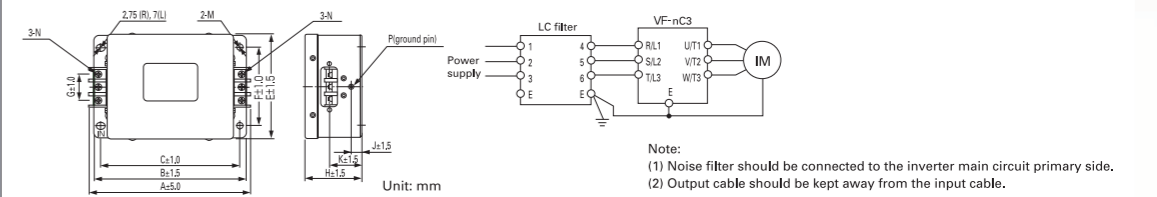

Model	Rated current (A)	Inverter type		Dimensions(mm)													Approx. weight (kg)
		VFNC3-	VFNC3S-	A	B	C	E	F	G	H	J	K	M	N	P		
NF3005A-MJ	5	2001P 2002P 2004P 2007P	1001P	174.5	160	145	110	80	32	70	20	45	φ5.5	M4	M4	1.0	
NF3015A-MJ	15	2015P 2022P	1002P 1004P													1.6	
NF3020A-MJ	20	2037P	1007P														

Simple radio noise reduction filter (capacitive filter)

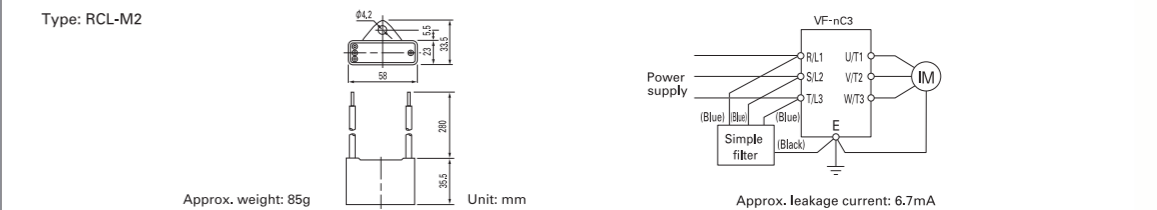

Type	Dimensions(mm)	Approx. weight
Type: RCL-M2	Approx. weight: 85g	
Type: RC5078	Approx. weight: 0.48kg	
Type: RC9129	Approx. weight: 1.38kg	

Zero-phase reactor core-type radio noise reduction filter

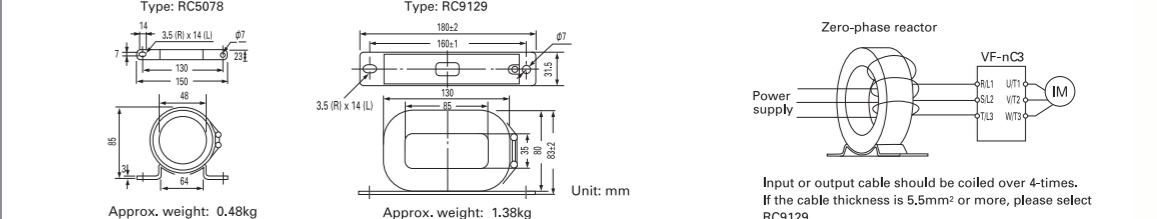

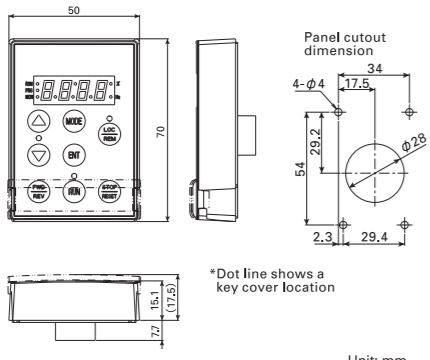
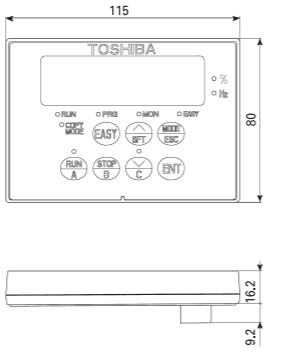
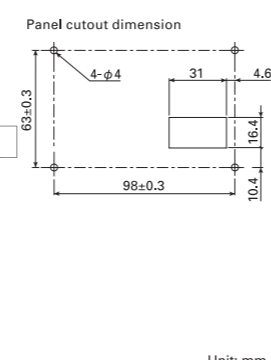
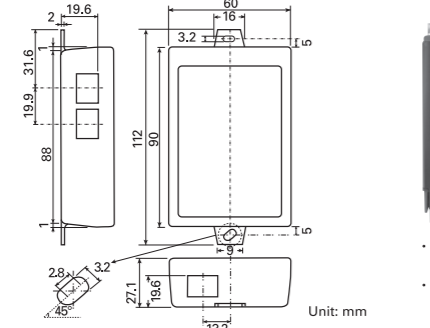
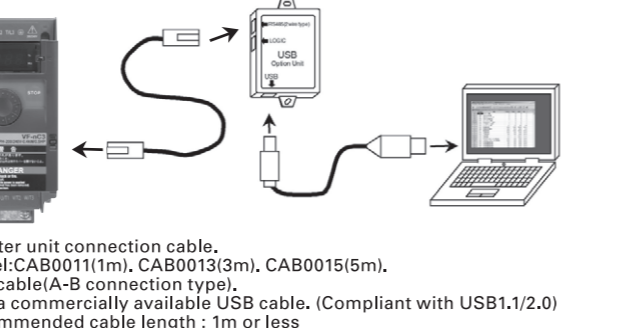
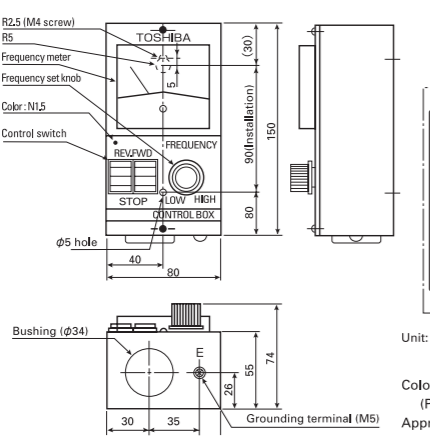
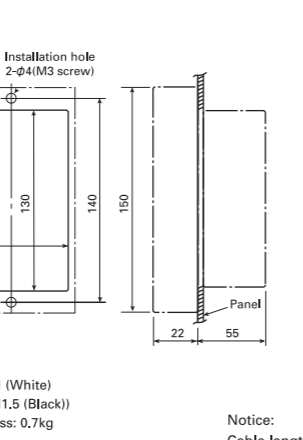
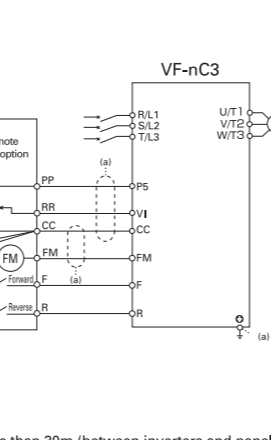
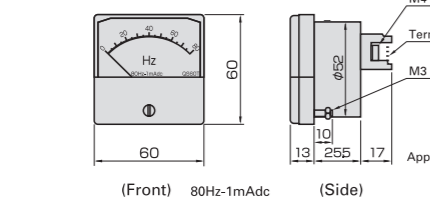
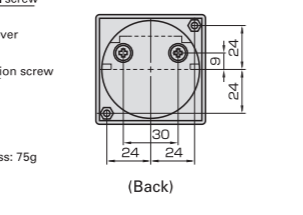
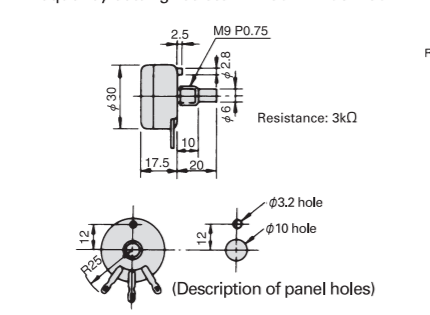
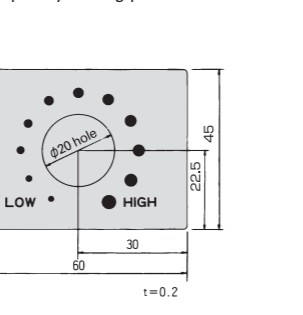
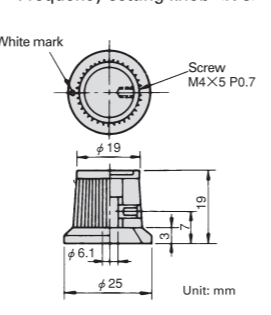
Devices	External dimensions and connections		
Extension panel	Type: RKP007Z  Unit: mm · Communication cable (option). Model : CAB0071(1m), CAB0073(3m), CAB0075(5m)	Type: RKP002Z  Unit: mm · Communication cable (option). Model : CAB0011(1m), CAB0013(3m), CAB0015(5m)	* With parameter writer function  Unit: mm
USB communications conversion unit	Type: USB001Z  Unit: mm	VF-nC3  · Inverter unit connection cable. Model: CAB0011(1m), CAB0013(3m), CAB0015(5m). · USB cable (A-B connection type). · USB a commercially available USB cable. (Compliant with USB1.1/2.0) Recommended cable length : 1m or less	
Remote panel	Type: CBVR-7B1  Unit: mm Color: 5Y7/1 (White) (Panel: N1.5 (Black)) Approx. mass: 0.7kg	Panel cutout dimension  Unit: mm	Connection  Notice: Cable length is less than 30m (between inverters and panels).
Frequency meter	Type: QS60T  (Front) 80Hz-1mAcd (Side) Approx. mass: 75g	Panel cutout dimension  Unit: mm Color(Case): Black(N1.5)	M4 terminal screw Terminal cover M3 installation screw Approx. mass: 75g
FRH kit	Frequency setting resistor <RV30YN-20S-B302>  Resistance: 3kΩ (Description of panel holes)	Frequency setting panel  Unit: mm t=0.2	Frequency setting knob <K-3>  Unit: mm

For inverter users

1. When studying how to use our inverters

Notes

Leakage current

This inverter uses high-speed switching semiconductors for PWM control. When a relatively long cable is used for power supply to an inverter, current may leak from the cable or the motor to the ground because of its capacitance, adversely affecting peripheral equipment. The intensity of such a leakage current depends on the PWM carrier frequency setting, the lengths of the input and output cables, etc., of the inverter. To prevent current leakage, it is recommended to take the following measures.

[Effects of leakage current]

Leakage current which increases when an inverter is used may pass through the following routes:

- Route (1) ...
Leakage due to the capacitance between the ground and the noise filter
- Route (2) ...
Leakage due to the capacitance between the ground and the inverter
- Route (3) ...
Leakage due to the capacitance between ground and the cable connecting the inverter and the motor
- Route (4) ...
Leakage due to the capacitance of the cable connecting the inverter and the motor in another power distribution line
- Route (5) ...
Leakage through the grounding line common to motors
- Route (6) ...
Leakage to another line because of the capacitance of the ground

Leakage current which passes through the above routes may cause the following trouble.

- Malfunction of a leakage circuit breaker (ELCB) in the same or another power distribution line
- Malfunction of a ground-relay installed in the same or another power distribution line
- Noise produced at the output of an electronic device in another power distribution line
- Activation of an external thermal relay installed between the inverter and the motor, at a current below the rated current

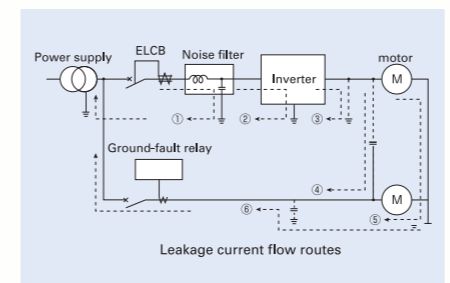

[Measures against effects of leakage current]

The measures against the effects of earth leakage current are as follows:

- 1) Measures to prevent the malfunction of leakage circuit breakers (ELCB)
 - (1) Decrease the PWM carrier frequency of the inverter. Note)

- (2) Use radio-frequency interference-proof ELCBs as ground-fault interrupters in not only the system into which the inverter is incorporated but also other systems. When the ELCBs are used, the PWM carrier frequency enable to be increased to operate the inverter.
- (3) When connecting multiple inverters to a single ELCB, use an ELCB with a high current sensitivity or reduce the number of inverters connected to the ELCB.
- 2) Measures against malfunction of ground-fault relay:
 - (1) Decrease the PWM carrier frequency of the inverter. Note)
 - (2) Install ground-fault relays with a high-frequency protective function in both the same and other lines. When the relays are used, the PWM carrier frequency enable to be increased to operate the inverter.
- 3) Measures against noise produced by other electric and electronic systems:
 - (1) Separate the grounding line of the inverter from that of the affected electric and electronic systems.
 - (2) Decrease the PWM carrier frequency of the inverter. Note)
- 4) Measures against malfunction of external thermal relays:
 - (1) Remove the external thermal relay and use the electronic thermal function of the inverter instead of it. (Unapplicable to cases where a single inverter is used to drive more than one motor. Refer to the instruction manual for measures to be taken when thermal relays cannot be removed.)
 - (2) Decrease the PWM carrier frequency of the inverter. Note)

- 5) Measures by means of wiring and grounding
 - (1) Use a grounding wire as large as possible.
 - (2) Separate the inverter's grounding wire from that of other systems or install the grounding wire of each system separately to the grounding point.
 - (3) Ground (shield) the main circuit wires with metallic conduits.
 - (4) Use the shortest possible cables to connect the inverter to the motor.
 - (5) If the inverter has a high-attenuation EMC filter, turn off the grounding capacitor detachment switch to reduce the leakage current. Note that doing so leads to a reduction in the noise attenuating effect.

Note) In the case of this inverter, the PWM carrier frequency can be decreased to 2.0kHz. Decreasing the carrier frequency results in an increase in electromagnetic noise from the motor.

Ground fault

Before beginning operation, thoroughly check the wiring between the motor and the inverter for incorrect wiring or short circuits. Do not ground the neutral point of any star-connected motor.

Radio interference

[Noise produced by inverters]

Since this inverter performs PWM control, it produces noise and sometimes affects nearby instrumental devices, electrical and electronic systems, etc. The effects of noise greatly vary with the noise resistance of each individual device, its wiring condition, the distance

between it and the inverter, etc.

[Measures against noises]

According to the route through which noise is transmitted, the noises produced by an inverter are classified into transmission noise, induction noise and radiation noise.

[Examples of protective measures]

- Separate the power line from other lines, such as weak-current lines and signal lines, and install them apart from each other.
- Install a noise filter in each inverter. It is effective for noise prevention to install noise filters in other devices and systems, as well.
- Shield cables and wires with grounded metallic conduits, and cover electronic systems with grounded metallic cases.
- Separate the power distribution line of the inverter from that of other devices and systems.
- Install the input and output cables of the inverter apart from each other.
- Use shielded twisted pair wires for wiring of the weak-current and signal circuits, and always ground one of each pair of wires.
- Ground the inverter with grounding wires as large and short as possible, separately from other devices and systems.

1ph-240V models have built-in EMC noise filters on their input side, and reduce noise greatly.

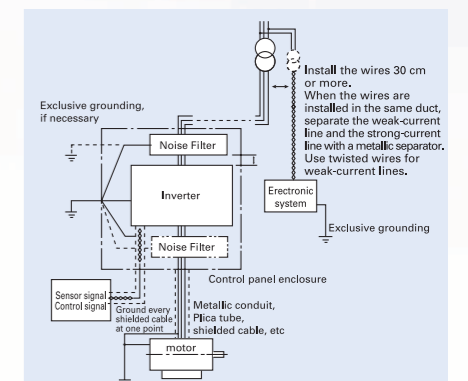

Power factor improvement capacitors

Do not install a power factor improvement capacitors on the output side of the inverter.

Installing a power factor improvement capacitor on the output side causes current containing harmonic components to flow into the capacitor, adversely affecting the capacitor itself or causing the inverter to trip. To improve the power factor, install an input AC reactor on the primary side of the inverter or install a DC reactor.

Installation of input AC reactors

These devices are used to improve the input power factor and suppress high harmonic currents and surges. Install an input AC reactor when using this inverter under the following conditions:

- (1) When the power source capacity is 200kVA or more, and when it is 10 times or more greater than the inverter capacity.
- (2) When the inverter is connected the same power distribution system as a thyristor-committed control equipment.
- (3) When the inverter is connected to the same power distribution system as that of distorted wave-producing systems, such as arc furnaces and large-capacity inverters.

2. Selecting the Capacity (model) of the Inverter

○ Selection

Capacity

Refer to the applicable motor capacities listed in the standard specifications.

When driving some motors in parallel, select such an inverter that the sum of the motor rated current multiplied by 1.05 to 1.1 is less than the inverter's rated output current value.

Acceleration/deceleration times

The actual acceleration and deceleration times of a motor driven by an inverter are determined by the torque and moment of inertia of the load, and can be calculated by the following equations.

The acceleration and deceleration times of an inverter can be set individually. In any case, however, they should be set longer than their respective values determined by the following equations.

Acceleration time	$t_a = \frac{(JM+JL) \times \Delta N}{9.56 \times (TM-TL)}$ (sec.)
Deceleration time	$t_d = \frac{(JM+JL) \times \Delta N}{9.56 \times (TB+TL)}$ (sec.)
Conditions	<p>JM : Moment of inertia of motor (kg,m²) JL : Moment of inertia of load (kg,m²) (converted into value on motor shaft) ΔN : Difference in rotating speed between before and after acc. or dec. (min.⁻¹) TL : Load torque (N,m) TM : Motor rated torque x 1.2 to 1.3 (N,m) ... V/f control ... Motor rated torque x 1.5 (N,m) ... Vector operation control TB : Motor rated torque x 0.2 (N,m) (When a braking resistor or a braking resistor unit is used.) Motor rated torque x 0.8 to 1.0 (N,m)</p>

Allowable torque characteristics

When a standard motor is combined with an inverter to perform variable speed operation, the motor temperature rises slightly higher than it normally does during commercial power supply operation. This is because the inverter output voltage has a sinusoidal (approximate) PWM waveform. In addition, the cooling becomes less effective at low speed, so the torque must be

reduced according to the frequency. Regarding the allowable torque characteristic, please confirm its motor manufacturer.

When constant-torque operation must be performed at low speeds, use a Toshiba VF motor designed specifically for use with inverters.

Starting characteristics

When a motor is driven by an inverter, its operation is restricted by the inverter's overload current rating, so the starting characteristic is different from those obtained from commercial power supply operation.

Although the starting torque is smaller with an inverter than with the commercial power supply, a high starting torque can be produced at low speeds by adjusting the V/f pattern torque boost amount or by employing vector control. When a larger starting torque is necessary, select an inverter with a larger capacity and examine the possibility of increasing the motor capacity.

3. When installing, wiring and operating the inverter

○ Selection

Installing precautions

- Do not install in any location of high temperature, high humidity, moisture condensation and freezing. Do not install the inverter where there are gases that corrode metal or solvents that adversely affect plastic. Avoid locations where there is exposure to water and/or where there may be large amounts of dust and metallic fragments. In this case, please install inverters in the enclosure type cabinet. The cabinet must be considered its size and the cooling method to allow the specifications of an ambient temperature for inverters.
- Must be installed in non-inflammables such as metals. The rear panel gets very hot. If installation is in an inflammable object, this can result in fire.
- Inverters should be arranged in horizontal rows.

Wiring precautions

Installing a molded-case circuit breaker [MCCB]

- Install a molded-case circuit breaker (MCCB) on the inverter's power supply input to protect the wiring.
- Avoid turning the molded-case circuit breaker on and off frequently to turn on/off the motor. To turn on/off the motor frequently, close/break the control terminals F (or R)-CC.

Installing a magnetic contactor [MC] [primary side]

- To prevent an automatic restart after the power interruption or overload relay has tripped, or actuation of the protective circuit, install an electro-magnetic contact in the power supply.
- The inverter is provided with a fault detection relay (FL), so that, if its contacts are connected to the operation circuit of the magnetic contactor on the primary side, the magnetic contactor will be opened when the protective circuit of the inverter is activated.
- The inverter can be used without a magnetic contactor. In this case, use an MCCB (equipped with a voltage tripping device) for opening the primary circuit when the inverter protective circuit is activated.

- Avoid turning the magnetic contactor on and off frequently to turn on/off the motor.
- To turn on/off the motor frequently, close/break the control terminals F (or R)-CC.
- Install surge suppressor on any magnetic contactor and relay coils used around the inverter.
- If using a braking resistor, install a magnetic contactor (MC) to the power supply of the inverter, so that the power circuit opens when the internal overload relay of the braking resistor is activated.

Installing a magnetic contactor [MC] [secondary side]

- As a rule, if a magnetic contactor is installed between the inverter and the motor, do not turn on/OFF while running. (If the secondary-side contactor is turned of ON/OFF while running, a large current may flow in the inverter, causing inverter damage and failure.)
- A magnetic contactor may be installed to change the motor or change to the commercial power supply when the inverter is stopped. Always use an interlock with the magnetic contactor in this situation so that the commercial power supply is not applied to the inverter's output terminals.

External signal

- Use a relay rated for low currents. Mount a surge suppressor on the excitation coil of the relay.
- When wiring the control circuit, use shielded wires or twisted pair cables.
- Because all of the control terminals except FLA, FLB and FLC are connected to electronic circuits, insulate these terminals to prevent them from coming into contact with the main circuit.

Installing an overload relay

- This inverter has an electronic-thermal overload protective function. However, in the following cases, the thermal relay operation level must be adjusted or an overload relay matching the motor's characteristics must be installed between the inverter and the motor.
 - When using a motor having a rated current value different from that of the equivalent.
 - When driving several motors simultaneously.

- When using the inverter to control the operation of a constant-torque motor (VF motor), change the protective characteristic of the electronic thermal relay according to the setting of the VF motor.
- In order to adequately protect a motor used for low-speed operation, we recommend the use of a motor equipped with an embedded thermal relay.

Wiring

- Do not connect input power to the output (motor side) terminals (U/T1,V/T2,W/T3). That will destroy the inverter and may result in fire. Please pay attentions of wiring before power supply turns-on.
- The DC terminals (PA+, PO and PC-) are for specified options. Do not connect other devices to these terminal.
- Within 15 minutes after turning off input power, do not touch wires of devices connected to the input side of the inverter.

Grounding

The inverters and motors must be connected to ground securely. In case of grounding for inverters, please use the grounding terminal of the inverter.

○ Operating precautions

- The inverter operates in abnormal circumstances the security function, and stops outputting. However, the inverters can not stop the motors quickly. Please install the mechanical brake or maintenance function in the mechanical equipment and the device for which the emergency stop is necessary.
- When you drive the machine and the device that hangs the load repeatedly with the inverter, the semiconductor within inverter might cause thermal fatigue, and it come to have a short life if a big current flows repeatedly when driving and stopping. In this case, it is possible to extend life span by controlling the starting current and the load current low or setting the PWM carrier frequency low. If you can not decrease the starting current, please select larger capacity of inverters for current margins.

4. When changing the motor speed

○ Application to standard motors

Vibration

When a motor is operated with an industrial inverter, it experiences more vibrations than when it is operated by the commercial power supply. The vibration can be reduced to a negligible level by securing the motor and machine to the base firmly. If the base is weak, however, the vibration may increase at a light load due to resonance with the mechanical system.

Setting the jump frequency or changing the PWM carrier frequency enable to reduce vibration.

Acoustic noise

The magnetic noise of motors with inverter drives is changed by PWM carrier frequency. In case of high PWM carrier frequency settings, its acoustic noise is almost same as commercial power supply drives. Moreover, when the motors are operated over rated rotation, the windy noise of the motors is increased.

Reduction gear, belt, chain

Note that the lubrication capability of a reducer or a converter used as the interface of the motor and the load machine may affected at low speeds.

When operating at a frequencies exceeding 60 Hz or higher, power transmission mechanisms such as reduction gear, belts and chains, may cause problems such as production of noise, a reduction in strength, or shortening of service life.

Frequency

Before setting the maximum frequency to 60 Hz or higher, confirm that this operating range is acceptable for the motor.

Starting method

When you drive the motor with changeable connection between star-connection and delta-connection for decreasing starting current, please connect delta-connection only. If you

change motor connection while inverter drives, the protective function of inverter occurs.

○ Application to special motors

Gear motor

When using an inverter to drive a gear motor, inquire of the motor manufacturer about its continuous operation range due to the followings:

- The low-speed operation of a gear motor may cause insufficient lubrication
- The loss of a gear may be increasing than commercial power supply drives.
- In case of the high frequency operation, the acoustic noise and motor temperature may be higher.

Toshiba Gold Motor

(High-efficiency power-saving motor)

Inverter-driven operation of Toshiba Gold Motors is the best solution for saving energy. This is because these motors have improved efficiency, power factor, and noise/vibration reduction characteristics when compared to standard motors.

Pole-changing motor

Pole-changing motors can be driven by this inverter. Before changing poles, however, be sure to let the motor come to a complete stop. If you change motor connection while inverter drives, the protective function of inverter occurs.

Underwater motors

Note that underwater motors have higher rated current than general motors.

The current ratings of underwater motors are relatively high. So, when selecting an inverter, you must pay special attention to its current rating so that the current rating of the motor is below that of the inverter.

When the lengths of the motor cable are long, please use thicker cable than a table of "Wiring

devices" because the maximum torque is decreased by the voltage dropping. Moreover, please pay attention to select leakage circuit breakers.

Single-phase motor

Because single-phase motors are equipped with a centrifugal switch and capacitors for starting, they cannot be driven by an inverter. When single phase motors are driven by inverters, a centrifugal switch and capacitors may be broken. If only a single-phase, power system is available a 3-phase motor can be driven by using a single-phase input inverter to convert it into a 3-phase 240V output. (A special inverter and a 3-phase 240V motor are required.)

Braking motor

When using a braking motor, if the braking circuit is directly connected to the inverter's output terminals, the brake cannot be released because of the lowered starting voltage. Therefore, when using a braking motor, connect the braking circuit to the inverter's power supply side, as shown on the below. Usually, braking motors produce larger noise in low speed ranges.

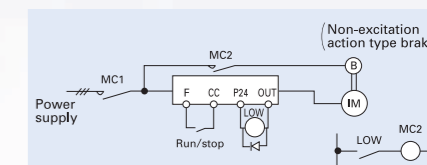

To users of our inverters : Our inverters are designed to control the speeds of three-phase induction motors for general industry.

 **Precautions**

- * Read the instruction manual before installing or operating the inverter unit and store it in a safe place for reference.
- * When using our inverters for equipment such as nuclear power control, aviation and space flight control, traffic, and safety, and there is a risk that any failure or malfunction of the inverter could directly endanger human life or cause injury, please contact our headquarters, branch, or office printed on the front and back covers of this catalogue. Special precautions must be taken and such applications must be studied carefully.
- * When using our inverters for critical equipment, even though the inverters are manufactured under strict quality control always fit your equipment with safety devices to prevent serious accident or loss should the inverter fail (such as issuing an inverter failure signal).
- * Do not use our inverters for any load other than three-phase induction motors.
- * None of Toshiba, its subsidiaries, affiliates or agents, shall be liable for any physical damages, including, without limitation, malfunction, anomaly, breakdown or any other problem that may occur to any apparatus in which the Toshiba inverter is incorporated or to any equipment that is used in combination with the Toshiba inverter. Nor shall Toshiba, its subsidiaries, affiliates or agents be liable for any compensatory damages resulting from such utilization, including compensation for special, indirect, incidental, consequential, punitive or exemplary damages, or for loss of profit, income or data, even if the user has been advised or apprised of the likelihood of the occurrence of such loss or damages.

For further information, please contact your nearest Toshiba Representative or International Operations-Producer Goods. The information in this brochure is subject to change without notice.

TOSHIBA INDUSTRIAL PRODUCTS SALES CORPORATION

International Operations

9-11, Nihonbashi-honcho 4-chome, Chuo-ku, Tokyo 103-0023, Japan
Tel : +81-(0)3-5644-5509, FAX : +81-(0)3-5644-5519
<http://www.tips.toshiba.com.au/>